

BOYER BRANSDEN ELECTRONICS LTD

Frindsbury House, Cox Lane, Detling, MAIDSTONE, Kent ME14 3HE ENGLAND
Telephone: 01622 730939 Fax: 01622 730930

Boyer Bransden Ignitions
Electrifying Performance
WWW.BOYERBRANSDEN.COM

KIT 00291

MICRO-POWER DIGITAL ELECTRONIC IGNITION SYSTEM FOR SUZUKI GS 550-1000 FOUR CYLINDER & GS 400-450 /GSX ELECTRONIC MODELS THIS SYSTEM MUST BE USED WITH SPECIAL DIGITAL COILS TYPE 00008

Comprising:-

- a) Transistor Box (Blue box with wires)
 - b) Stator Plate (round printed circuit board with two coils) GS 4 cyl. models: large stator plate (3 fixing screws), GSX twin models: small stator plate (2 fixing screws)
 - c) Magnetic Rotor (round plated steel unit with two magnets)
 - d) Plastic strap
 - e) Link wire and terminals.
- GSX models with electronic ignition and advance will require some mechanical modification to fit the rotor.*

Note: Two ignition coils type COIL00008 are required with this kit for the four cylinder.
One ignition coil type COIL00008 is required for a twin cylinder, no link wire is used.

General fitting instructions

(Tools required are the standard tool kit plus a 12mm socket spanner and strobe lamp).

- 1) Open seat and remove tools.
- 2) Turn off petrol and remove pipes.
- 3) Undo bolt at rear of petrol tank and remove tank.
- 4) Trace the black and white wires feeding to the ignition coils and pull apart the two connectors.
- 5) Disconnect the orange/white wire from the left hand ignition coil, (these are all pull-apart bullet connectors).
- 6) Lay the transistor box underneath the main frame tube behind the ignition coils and connect the transistor box to the disconnected wires from the ignition coils and wiring loom. All the wires on the transistor box have the appropriate male and female connectors so that, as long as the colours are matched, the wiring will be correct. This should leave just one black wire coming from the transistor box with a ring connector; this should be run back down the frame and connected to the black negative battery terminal.
- 7) The transistor box can now be strapped to the frame tube and the wires tidied, checking all connectors are good and tight. The red female connectors on the transistor box may need to be pinched up a little to make a good connection
- 8) Refit the tank and replace petrol pipes.
- 9) Remove the contact breaker cover from the right hand side of the engine.
- 10) Using the 12mm socket spanner, remove the centre bolt of the auto-advance unit and contact breaker cam.
- 11) Remove the screws securing the contact breaker plate and remove.
- 12) Disconnect the black and white wires to the contact breaker. Unscrew the condenser with the cable retaining clamp and remove the contact breaker assembly complete. The auto-advance mechanism should drop clear of the end of the crankshaft, leaving the contact breaker housing bare.
- 13) Remove the contact breaker cam from the advancer unit by twisting to expand the bob weights and pull off. The bob weights can be left in place or removed as they are no longer used. Remove the engine positioning nut from the centre bolt and refit the advancer unit to the end of the crankshaft with the centre bolt screwed in a few turns to hold it in place temporarily. Hold the metal timing mark plate back into position, fit the stator plate over it in the original position of the contact backing plate, with the timing hole at the top and the terminal screws at the bottom. Replace the screws, setting it approximately half way along its adjustment slots. Connect the black and white wires to the two screw terminals, with the black wire to the "BLACK" marked terminal and the white wire to the "WHITE" marked terminal. GSX models: connect the stator plate to the ignition box using the sleeved black and white wires and terminals supplied. Make sure that, when tightened, these connectors cannot foul the magnetic rotor or engine casing. The small metal clip is not used. Carefully remove the centre bolt and slide through the magnetic rotor, with the magnets towards the engine and away from the head of the bolt. Refit the centre bolt, sliding the magnetic rotor over the shaft of the auto-advancer unit. The centre bolt can now be lightly tightened so that the magnetic rotor can still be turned by hand. The magnetic rotor supplied has no direct location on the advancer shaft and can be fitted in any position, this is due to the dogs on the advancer shaft being placed in various positions by the manufacturer. (The electronic advance models will require the reluctor unit turned down to take the rotor.)
- 14) The method of timing is as shown in Fig.1, first set the engine to the "T" Top Dead Centre position mark on 1 and 4, or 2 and 3 cylinders (GS TWIN models: 1 or 2 cylinders). Move the rotor to the position shown in Fig.1, with the magnet in line with the centre of the pole pieces on the stator plate. Tighten the centre bolt, a small tap on the end of the rotor will make small indentations inside the rotor, providing greater location and giving a fitting position if the rotor is removed. After setting the timing (See 16) the marks in the rotor can be filled out to provide a positive locking and give more clearance to the cover.
- 15) Start the engine and run for 5 minutes to warm up the engine and ignition unit.
- 16) Connect the strobe lamp and time to the full advance mark, with the engine running at 4500 RPM. Align by moving the stator on its slotted holes. If you run out of adjustment move the rotor a little and retighten. The electronic advance can be seen by accelerating up from idle. This is operating from cranking speed. A small amount of advance will be seen at 5000 RPM, this is normal.
- 17) Check all screws are tight and refit cover, the timing is now set and requires no maintenance. The carburation, plug caps and spark plugs must be in good order. The spark plug gaps should not be opened up but left at the standard setting. WITH THIS DIGITAL SYSTEM 5000 OHM RESISTIVE SUPPRESSED PLUG CAPS MUST BE USED .1
- 18) Models fitted with an electronic tachometer may indicate double the actual RPM and will therefore need to be re-calibrated. Contact Boyer Bransden for re-calibration service.

Fig.2

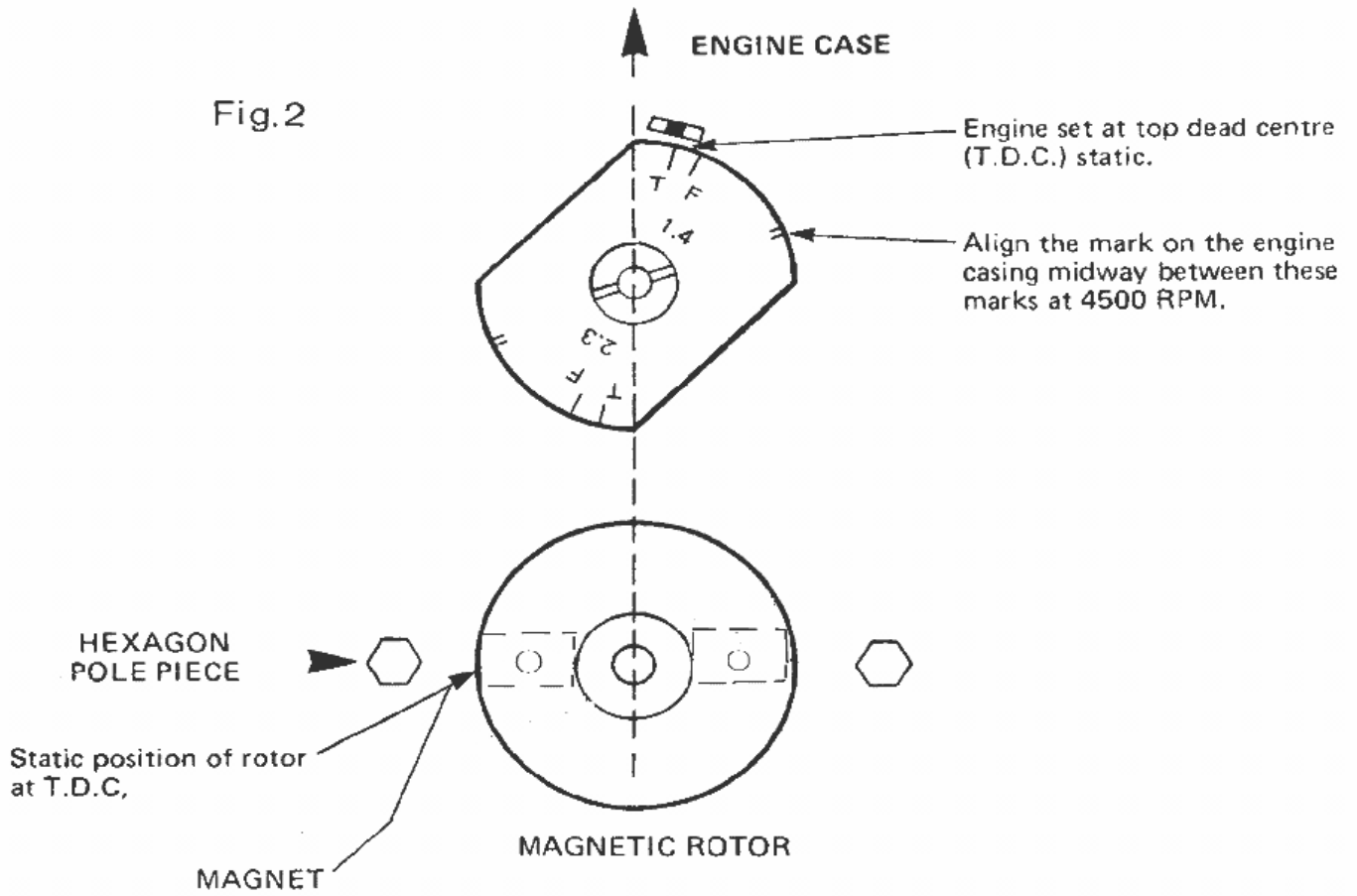

CIRCUIT DIAGRAM

